

KIT HOP

HOP KITS

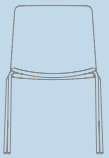



HOP 1690

Design: Bangdesign

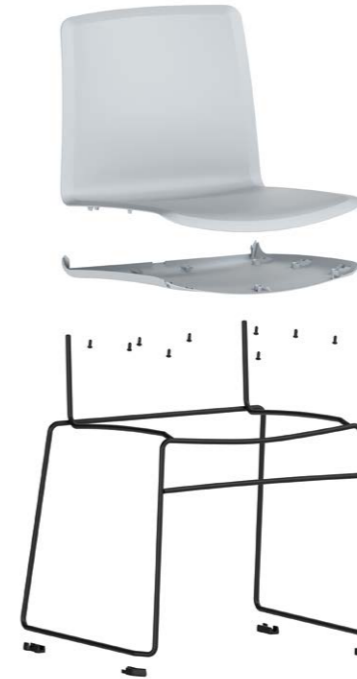

Hop è una seduta essenziale e altamente impilabile, progettata per spazi dinamici e collettivi. Le numerose varianti di telaio e di colore la trasformano in una collezione completa, capace di adattarsi a contesti diversi e a molteplici modalità d'uso. Accessori come la tavoletta scrittoio e il pannello sedile tappezzabile aumentano il comfort e la funzionalità, mentre l'impilabilità, anche su carrello, rende Hop una soluzione pratica e flessibile per ambienti in continua evoluzione.

Hop is an essential, highly stackable chair designed for dynamic, shared spaces. A wide range of frame and colour options turns it into a complete collection, adaptable to different settings and uses. Accessories such as the tablet arm and the upholstered seat panel enhance comfort and functionality, while stackability, also on a trolley, makes Hop a practical and flexible solution for ever-changing environments.



A FLEXIBLE SEATING SOLUTION
FOR CONTEMPORARY
SHARED ENVIRONMENTS.



HOP SLED



HOP SLED WITH ARMS



HOP 4 LEGS



HOP 5 STAR BASE





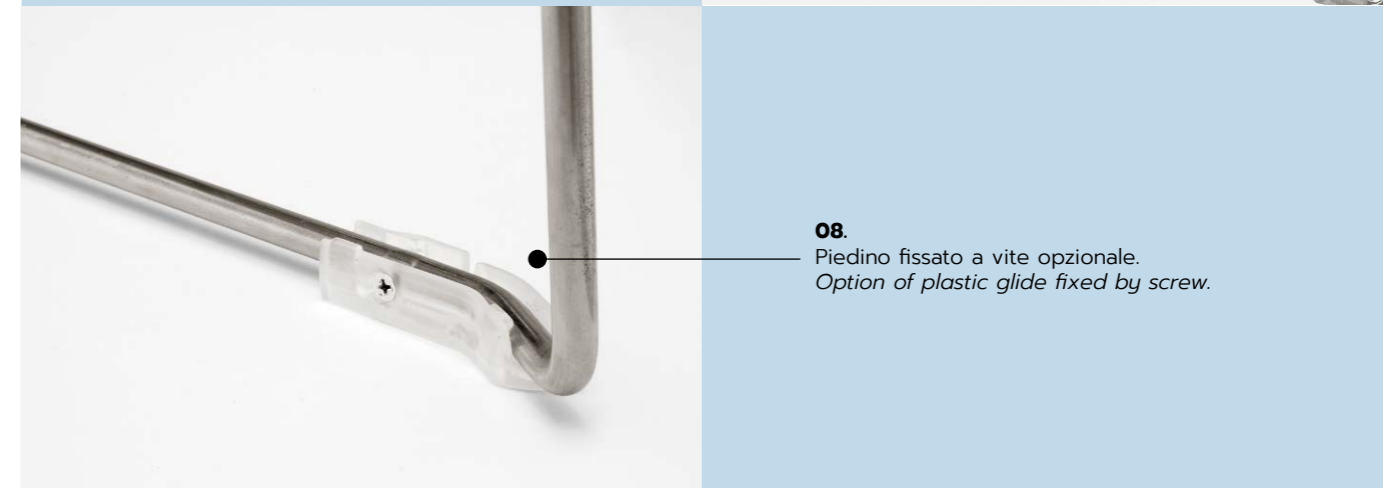
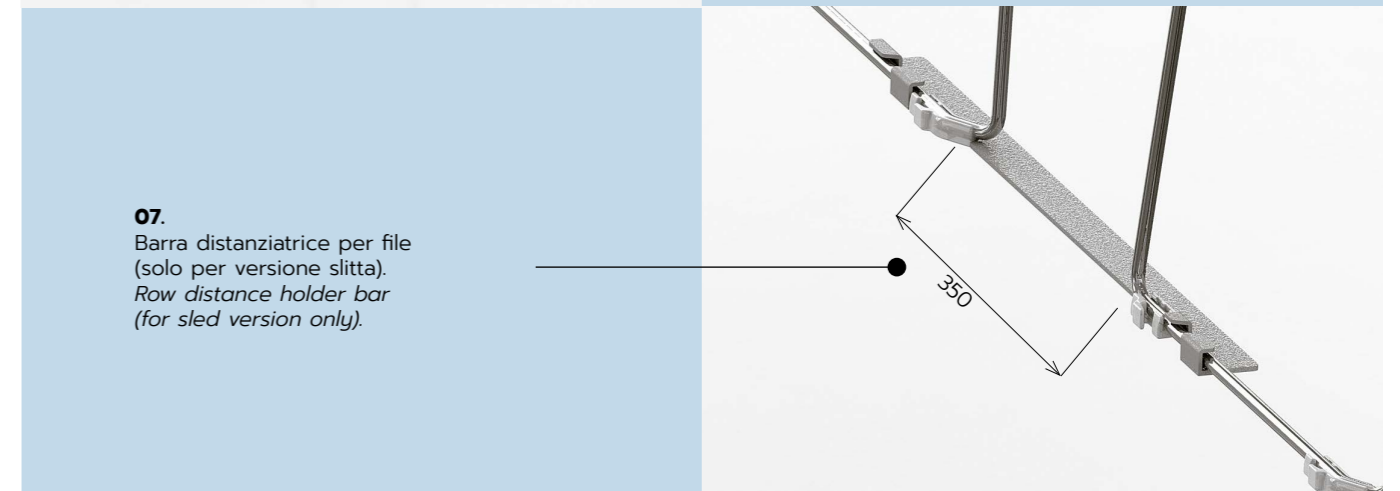
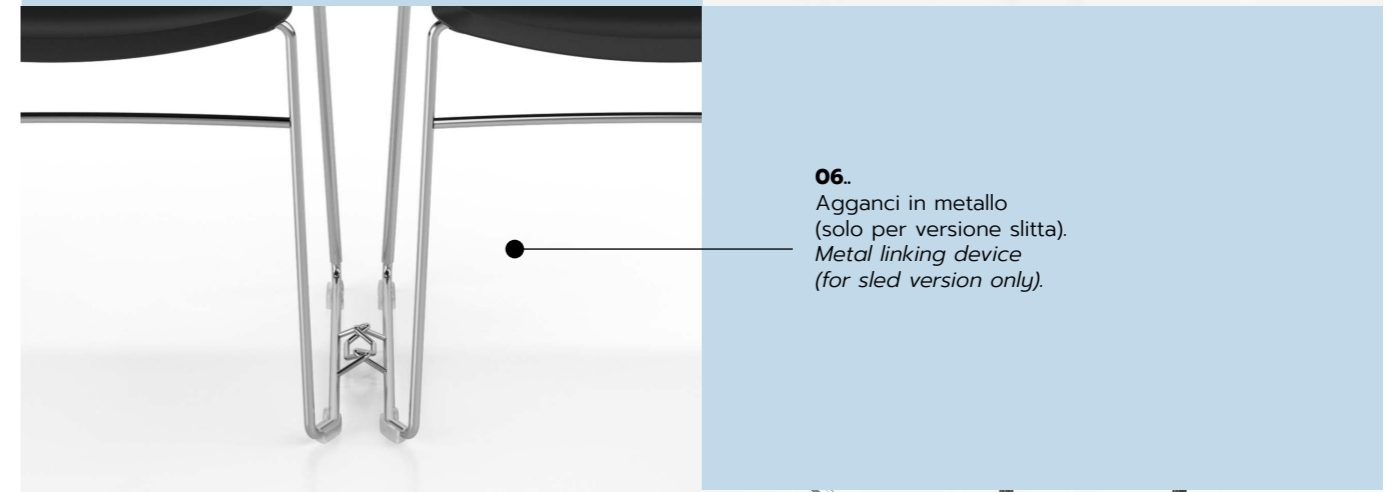
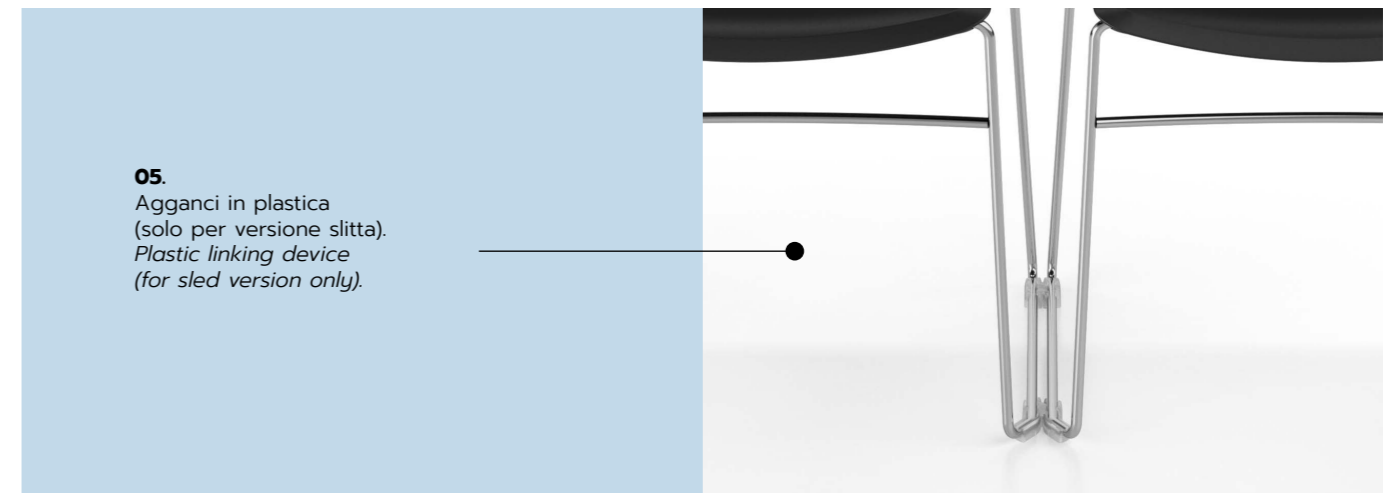
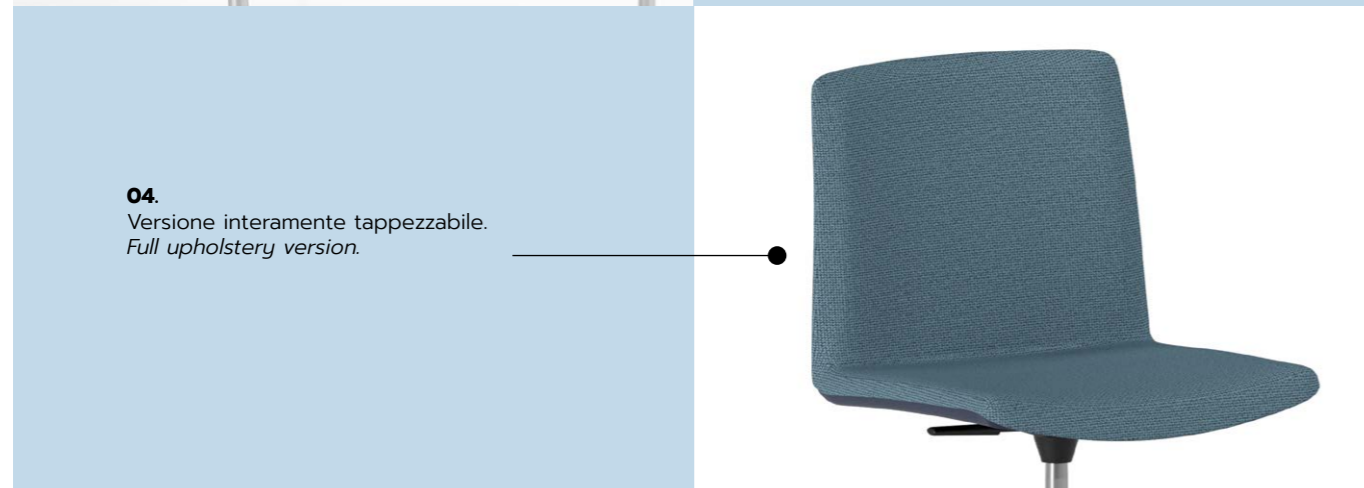
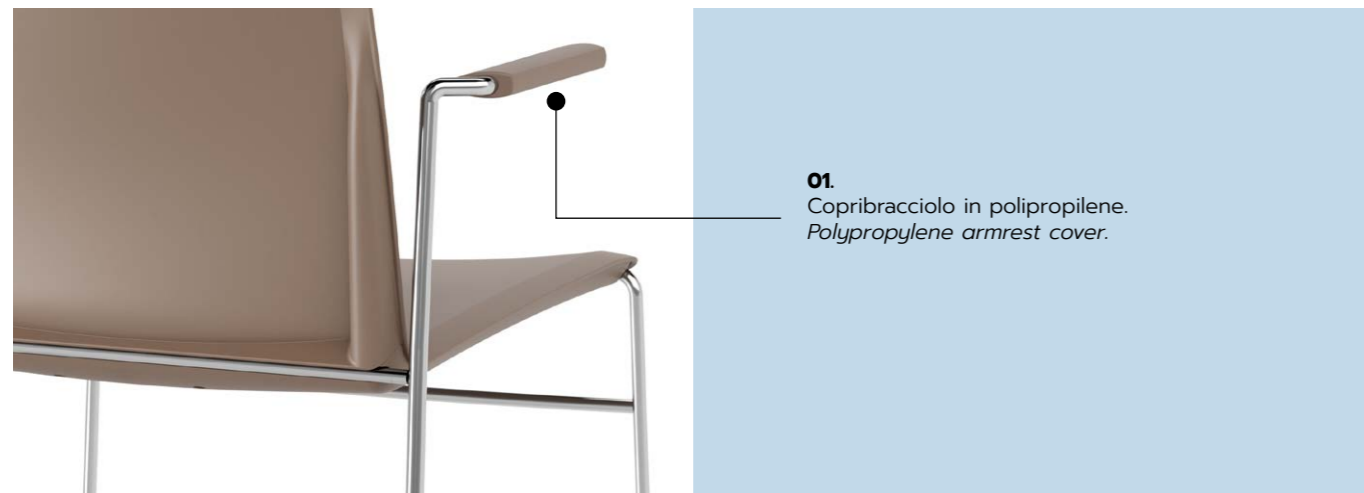



09.
Cestino portariviste.
Newspaper rack.

10.
Bracciolo con tavoletta destro e sinistro.
Armrest with RH and LH tablet arm.



11.
Impilabilità fino a 10 sedie (per versione
slitta con e senza braccioli).
*Stackability up to 10 chairs (for sled
version with and without armrests).*

12.
Impilabilità fino a 7 sedie (per versione
4 gambe senza braccioli).
*Stackability up to 7 chairs (for 4-leg
version without armrests).*

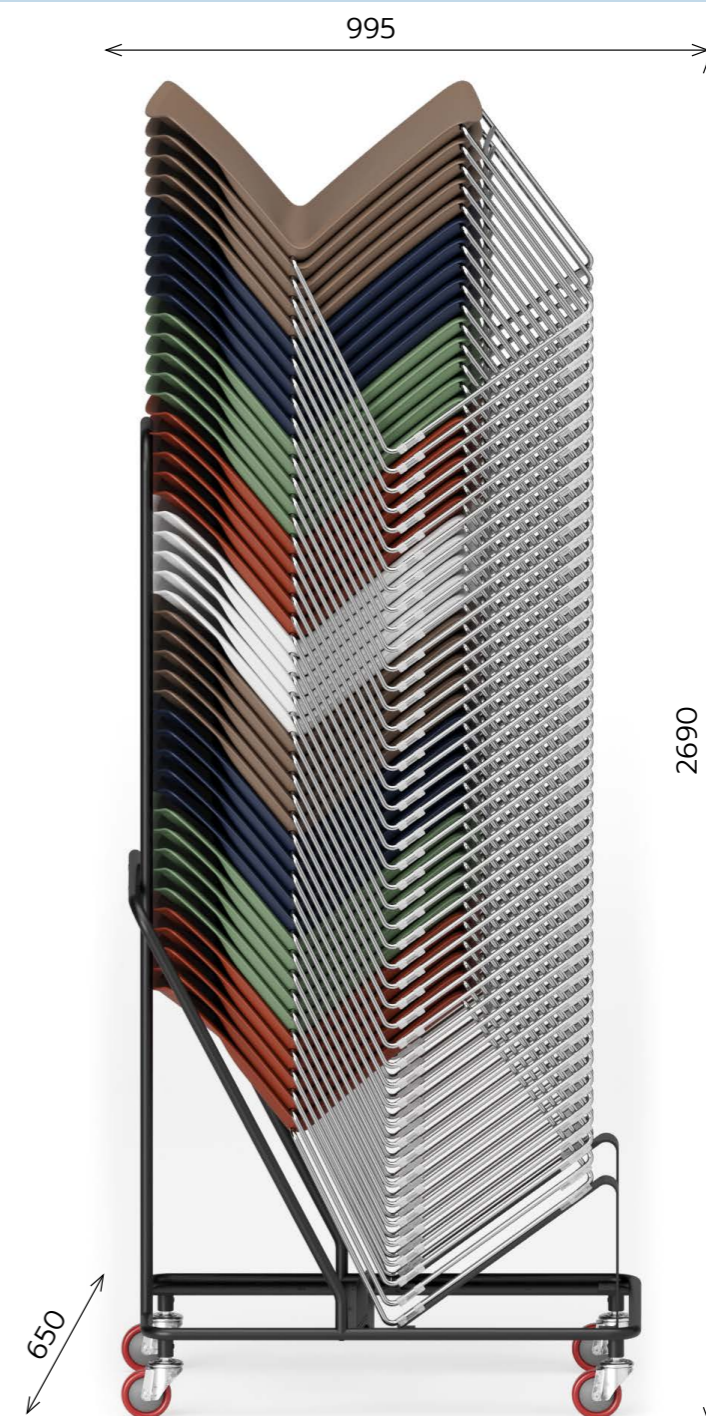

Impilabilità su carrello con inclinazione a 45°: fino a 45 per versione con telaio slitta, fino a 30 per versione con telaio 4 gambe.
Stackability on trolley with 45° inclination: up to 45 for version with sled frame, up to 30 for version with 4-leg frame.

HOP 1690

Design: Bangdesign

Realizzata in polipropilene, Hop combina resistenza, funzionalità e sostenibilità.

La scocca può essere abbinata a diverse tipologie di telaio – a 4 gambe, slitta, slitta con braccioli o base a 5 razze – dando vita a una collezione versatile, adatta a contesti differenti.

Le numerose configurazioni disponibili, insieme ad accessori come la tavoletta scrittoio, il pannello sedile tappezzabile e il cestino portariviste, ampliano le possibilità di utilizzo e il comfort.

Le versioni a 4 gambe e a slitta sono impilabili anche su carrello, mentre l'intera collezione è progettata per rispondere alle esigenze di spazi collettivi e ad uso intensivo.

Tutti i modelli sono conformi agli standard EN16139 livello 2 e ANSI-BIFMA X5.1.

Made of polypropylene, Hop combines strength, functionality and sustainability.

The shell can be combined with different frame options – 4-leg, sled, sled with armrests or 5-star base – creating a versatile collection suitable for a wide range of settings.

The many available configurations, together with accessories such as the tablet arm, upholstered seat panel and magazine rack, enhance comfort and extend usability.

The 4-leg and sled versions are also stackable on a trolley, while the entire collection is designed to meet the demands of shared spaces and intensive use.

All models comply with EN16139 level 2 and ANSI-BIFMA X5.1 standards.

HOP 4 LEGS

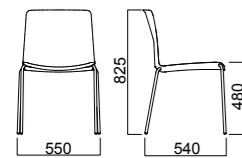

HOP SLED

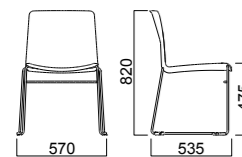

HOP SLED WITH ARMS

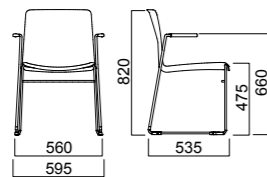

HOP SLED WITH TABLET

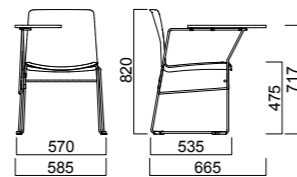

HOP 5-STAR BASE

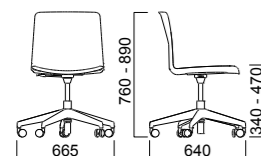

Colori plastiche



Nero
Black



Bianco
White



Grigio perla
Pearl grey



Marsala
Marsala



Blu navy
Navy blue



Tabacco
Tobacco



Verde Matcha
Matcha green

Hop, nel Grigio Perla, è certificata PSV MixEco, con almeno il 30% di plastica riciclata (PIR).
Hop, in Pearl Grey is PSV MixEco certified, made with at least 30% recycled plastic (PIR).



Grigio perla
Pearl grey

Leggere variazioni di tono o piccole impurità superficiali non costituiscono difetto, ma rappresentano una caratteristica del materiale proveniente da fonti di riciclo.

Slight variations in colour or minor surface imperfections do not constitute defects but are characteristic of material sourced from recycling.

Parti in metallo

Metal parts



Verniciato nero goffrato
Embossed black painted



Verniciato bianco goffrato
Embossed white painted

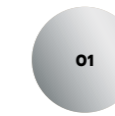

Cromato lucido
Chromium plated



Nero
Black

Colori plastiche base

Base plastic colours

Basi in alluminio

Aluminium bases



Verniciato nero goffrato
Embossed black painted

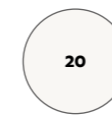

Verniciato bianco goffrato
Embossed white painted



Alluminio verniciato
Polished aluminium

Certificazioni

Certifications

EN16139 LIVELLO 2
ANSI-BIFMA



PSV MIX ECO



OMP S.R.L. - VIA CA' LEONCINO, 2 - 31030 CASTELLO DI GODEGO (TV) ITALY
TEL. +39 0423/7616

www.ompgroup.com